



RZI30-12-MN, RZI30-24-MN

power supplies



- Direct mounting on 35 mm rail mount acc. to EN 60715
- DC O/P voltage adjustable
- Universal input 90...264 V AC
- Class II power supply • Ultra slim stap shape
- Protection: short circuit, overload, overvoltage
- Applications: in industrial automation, for supplying household appliances and building automation
- Recognitions, certifications, directives: RoHS,  

Output circuit

	RZI30-12-MN	RZI30-24-MN
Rated output voltage	12 V DC	24 V DC
Output voltage tolerance	± 5% (initial set point tolerance from factory)	
Output voltage adjustment range	11...13 V DC	23...25 V DC
Output current	2 A	1,25 A
Rated output power	24 W	30 W
Line regulation	< 1% 90...264 V AC, 100% load	
Load regulation	< 1% 90...264 V AC, 0...100% load	
PARD (20 MHz) 	< 150 mVpp	
Rise time	< 50 ms rated voltage, 100% load	
Start-up time	< 500 ms rated voltage, 100% load	
Hold-up time	> 12 ms 115 V AC > 30 ms 230 V AC, 100% load	
Dynamic response	± 5% 10...100% load	
Start-up with capacitive loads	max. 3 000 µF	

Input circuit

Rated input voltage	100...240 V AC	125...375 V DC
Input voltage range	90...264 V AC	120...370 V DC
Rated input frequency	50...60 Hz	
Input frequency range	47...63 Hz	
Input current	< 1,2 A 115 V AC < 0,68 A 230 V AC	
Efficiency at 100% load	> 88% 230 V AC	> 89% 230 V AC
Max. make current	< 25 A 115 V AC < 45 A 230 V AC, cold start	
Power factor	conform to EN 61000-3-2	
Leakage current	< 0,25 mA 240 V AC	

General data

Dimensions (L x W x H)	90 x 35,2 x 58,4 mm	
Weight	120 g	
Ambient temperature	• storage	-40...+80 °C
	• operating	-20...+50 °C
Power de-rating	> 50 °C de-rate power by 2,5% / °C	
Relative humidity	20...90% (non-condensation and/or icing)	
Operating altitude	0...2 000 m	
Shock resistance	IEC 60068-2-27, half sine wave: 4G for a duration of 22 ms, 3 shocks for each 3 directions, 9 times in total	
Vibration resistance	IEC 60068-2-6, sine wave: 10...500 Hz at 19,6 m/s ² (peak: 2G), 10 min. per cycle, 60 min. for all directions (X, Y, Z)	
Overvoltage category	II	
Insulation pollution degree	2	
Galvanic isolation	• input - output	3 000 V AC

Protections

Overvoltage	110...145% clamp by Zener diode
Overload / overcurrent	> 130...200% rated output power Hiccup mode: recovers automatically after fault condition removed
Short circuit	Hiccup mode
Cover protection category	IP 20 EN 60529
Protection against shock	Class II (double insulation)

 PARD (20 MHz): Periodic and Random Deviation from the power supply's output DC voltage measured at 20 MHz bandwidth.

RZI30-12-MN, RZI30-24-MN

power supplies

Reliability data

MTBF (mean time between failures)	> 3 120 000 h Telcordia SR-332, I/P: 100 V AC, O/P: 100% load, Ta: 35 °C
Expected lifetime of capacitors	10 years 115 V AC, 230 V AC, 50% load, 40 °C
Safety standards, directives	
Electrical safety	EN 62368-1:2014+A11, Limited Power Source (LPS)
CE	EMC Directive 2014/30/EU Low Voltage Directive 2014/35/EU
Material and parts	RoHS Directive 2011/65/EU
EMC according to Directive 2014/30/EU	
EMC (emissions)	CISPR 32, EN 55032
Immunity to:	EN 55035
• electrostatic discharge (IEC 61000-4-2)	criteria B air discharge: 8 kV, contact discharge: 4 kV
• radiated field (IEC 61000-4-3)	criteria A 80 MHz...1 GHz, 3 V/M with 1 kHz tone / 80% modulation
• electrical fast transient / burst (IEC 61000-4-4)	criteria B 1 kV
• surge (IEC 61000-4-5)	criteria B line to line: 1 kV
• conducted (IEC 61000-4-6)	criteria A 150 kHz...80 MHz, 3 Vrms
• power frequency magnetic fields (IEC 61000-4-8)	criteria A 1 A/m
• voltage dips (IEC 61000-4-11)	criteria B&C
• low energy pulse test (ring wave) (IEC 61000-4-12)	N/A
Voltage fluctuation and flicker	IEC/EN 61000-3-3

De-rating for vertical mounting orientation. > 55 °C de-rate power by 2,5% / °C

Fig. 1

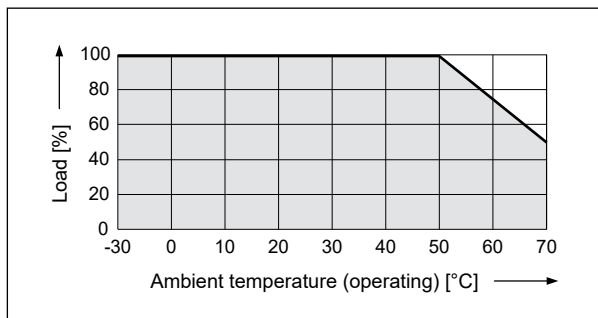

Output de-rating depending on input voltage

Fig. 2

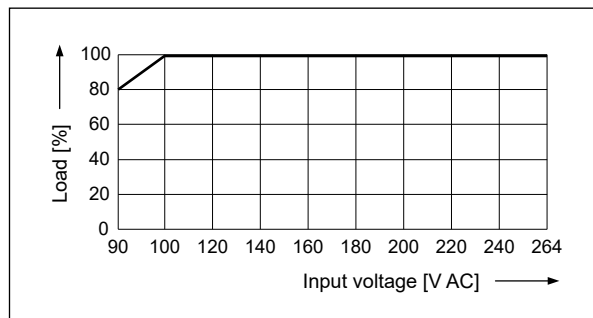

RZI30-12-MN, RZI30-24-MN

power supplies

Dimensions

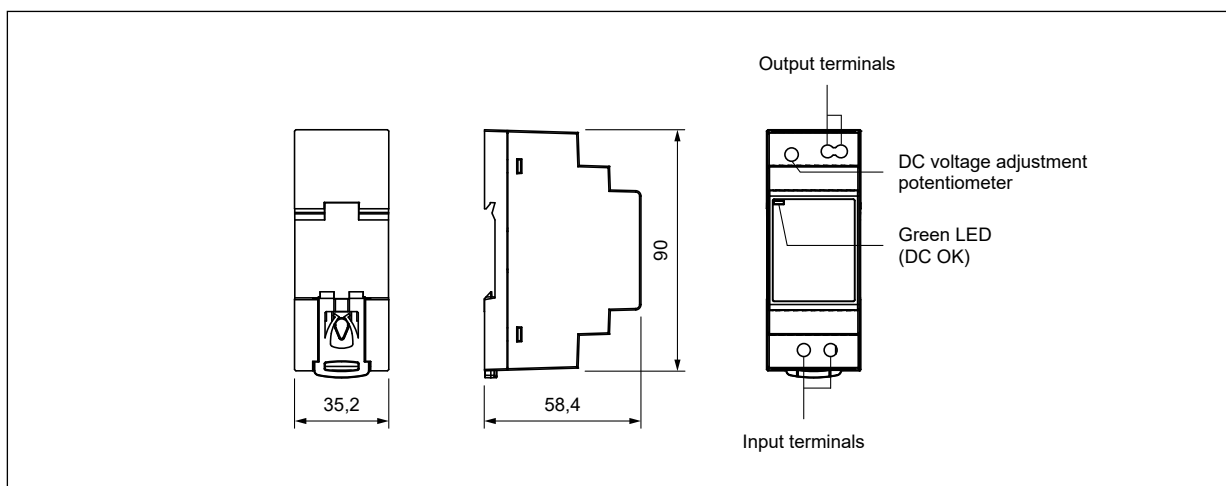

Mounting

Power supplies **RZI30-12-MN**, **RZI30-24-MN** are designed for direct mounting on 35 mm rail mount acc. to EN 60715. Operational position - vertical with input terminals on the bottom of the device. **Connections:** conductor cross section: 0,8...3,3 mm² (18...12 AWG), input terminals: screw connector, 2 screws M2,5 (20 A / 300 V), output terminals: screw connector, 2 screws M2,5 (20 A / 300 V).

Block diagram

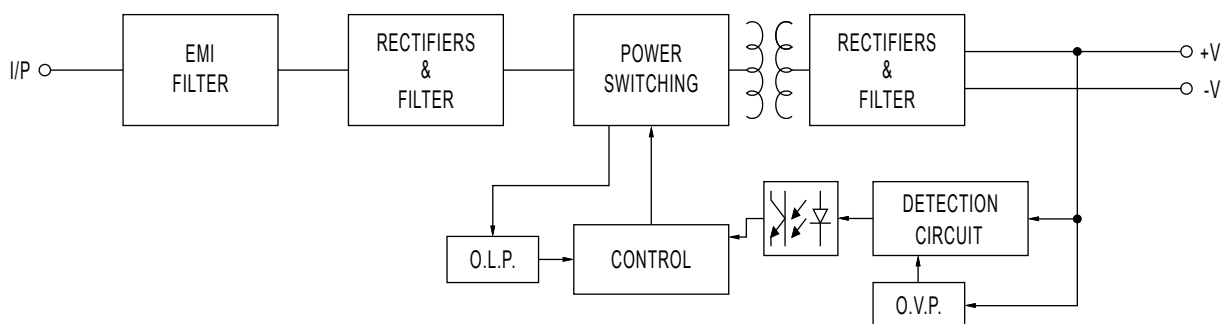

PRECAUTIONS:

1. Ensure that the parameters of the product described in its specification provide a safety margin for the appropriate operation of the device or system and never use the product in circumstances which exceed the parameters of the product. 2. Never touch any live parts of the device. 3. Ensure that the product has been connected correctly. An incorrect connection may cause malfunction, excessive heating or risk of fire. 4. In case of any risk of any serious material loss or death or injuries of humans or animals, the devices or systems shall be designed so to equip them with double safety system to guarantee their reliable operation.